

IMPORTANT - READ CAREFULLY BEFORE INSTALLING FIXTURE. RETAIN THESE INSTRUCTIONS FOR FUTURE REFERENCE. THIS PRODUCT MUST BE INSTALLED IN ACCORDANCE WITH THE NATIONAL ELECTRICAL CODE AND ALL APPLICABLE LOCAL CODES, BY A PERSON FAMILIAR WITH THE CONSTRUCTION AND OPERATION OF THE PRODUCT, AND THE HAZARDS INVOLVED. PROPER GROUNDING IS REQUIRED FOR SAFETY.

⚠ DISCONNECT THE MAIN LINE BEFORE WIRING SECONDARY CONNECTORS.

IN-LINE UNIT INSTALLATION INTEGRAL DRIVER (120 / 277V) DIMMING TRIAC/ELV (15%), 0-10V (1%), LUTRON HI-LUME® (1% EcoSystem™ / 1% 2-WIRE)

- A- MAKE CEILING CUT-OUT (SEE TABLE ON PAGE 3).
- B- OPEN THE CONNECTION BOXES ON TOP OF THE FIXTURE. UNSCREW THE BOXES PHILLIPS SCREW TO SLIDE OUT THE COVER. (SEE DETAIL 1)
- C- INSERT AND LOCK THE BX CABLE (NOT INCLUDED) INTO THE BX CONNECTORS (INCLUDED) AND MAKE NECESSARY WIRE CONNECTIONS (SEE WIRING DIAGRAM) USING TWIST CONNECTORS (NOT INCLUDED).
- D- WITH THE MOUNTING BRACKETS IN THE NARROW POSITION, GENTLY INSERT THE FIXTURE INTO THE CEILING CUT-OUT.
- E- SCREW THE MOUNTING BRACKET SCREWS CLOCKWISE TO WIDEN AND LOWER THE MOUNTING BRACKETS ON THE CEILING. (SEE DETAIL 2)
- F- CONNECT THE FIXTURES USING THE QUICK CONNECTORS (INCLUDED) AND SNAP THEM BACK INTO THE ALUMINUM EXTRUSION. FILL THE GAPS WITH THE COVER PLATES.

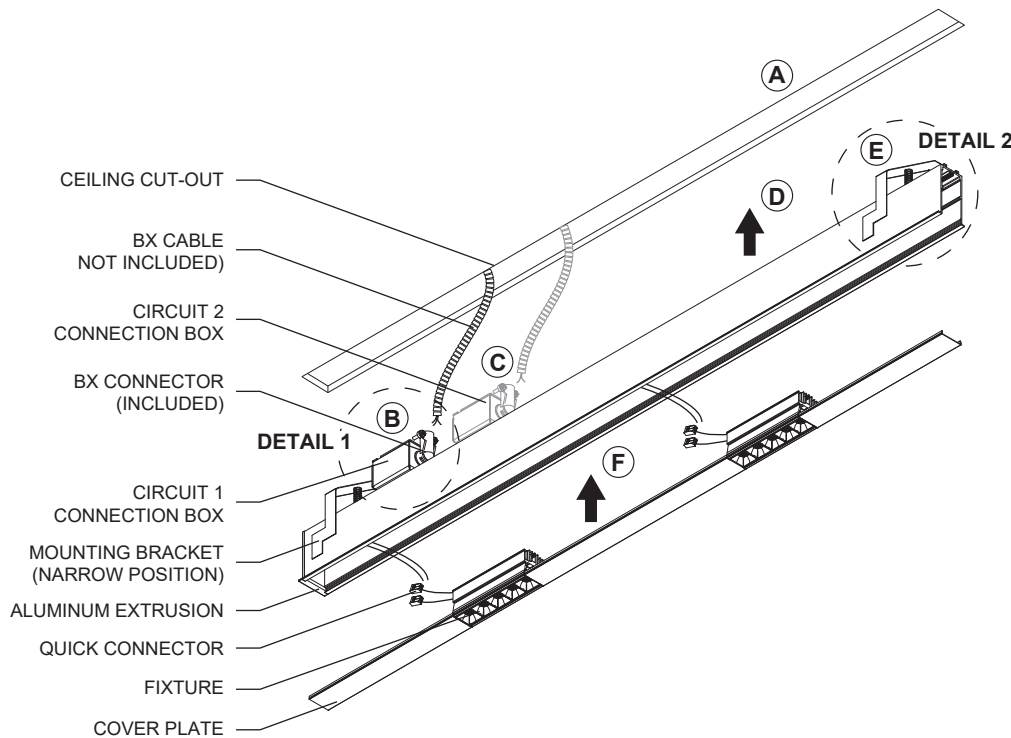

WIRING DIAGRAM

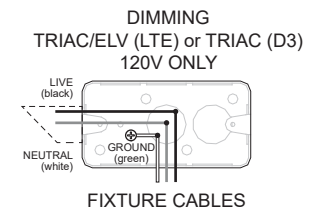
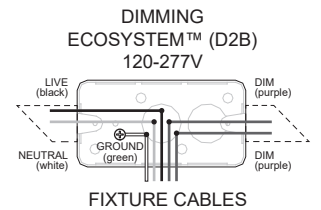
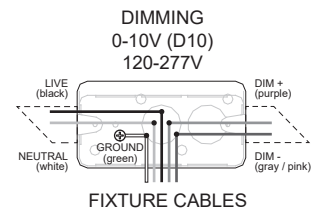

*for reference only

DETAIL 1

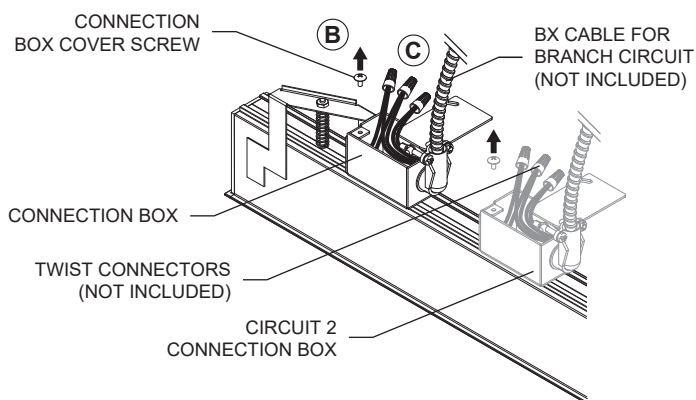

DETAIL 2

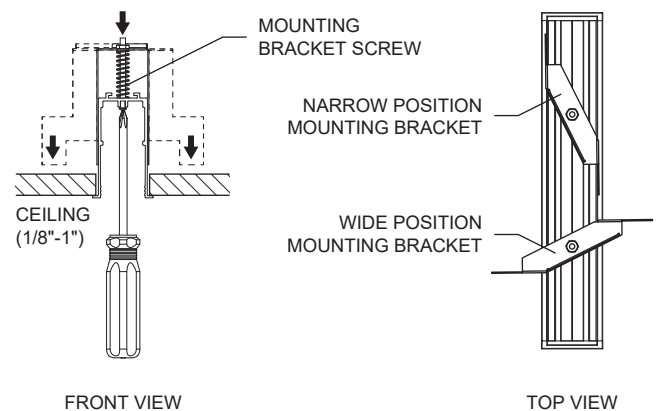

IN-LINE UNIT INSTALLATION (LENGTHS FROM 9' AND MORE)

- A- WITH MOUNTING BRACKETS IN THE NARROW POSITION, GENTLY INSERT THE IN-LINE FIXTURE INTO CEILING CUT-OUT AND SLIDE IT AGAINST THE INSTALLED FIXTURE UNIT. MAKE SURE NOT TO PINCH ANY WIRES.
- B- SCREW MOUNTING BRACKET SCREWS CLOCKWISE TO SECURE FIXTURE UNIT. BEFORE ANCHORING, MAKE SURE THERE IS NO GAP BETWEEN FIXTURE UNITS.
- C- FASTEN THE MECHANICAL JOINER SCREW TO THE IN-LINE UNIT. (SEE DETAIL 3 FOR LAST UNIT ASSEMBLY)
- D- REPEAT STEPS I TO K FOR ALL JOINTS.
- E- MAKE THE NECESSARY CONNECTIONS USING THE QUICK CONNECTORS BETWEEN UNITS.
- F- SNAP-IN PLACE COVER PLATE TO CLOSE THE OPENING.

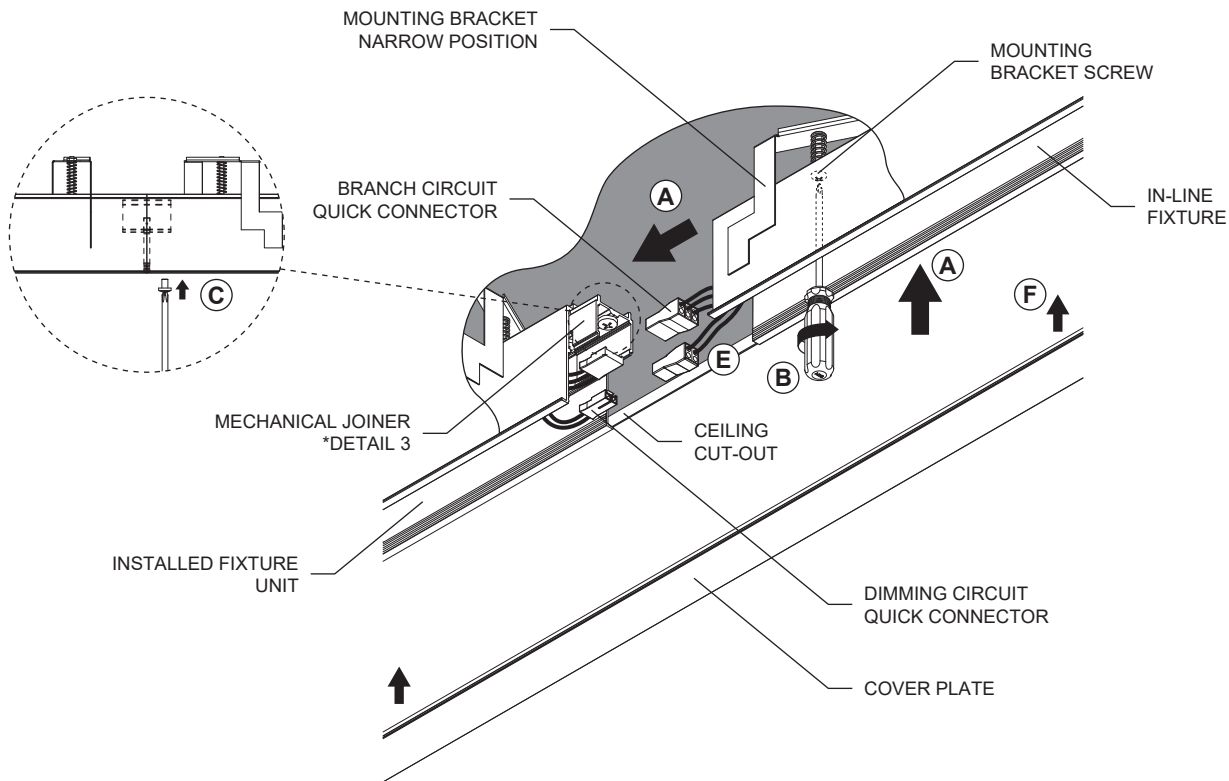

DETAIL 2

- 1- LOOSEN MECHANICAL JOINER PHILLIPS SCREWS.

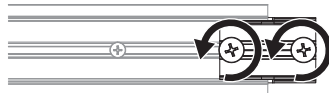

- 2- PUSH MECHANICAL JOINER INSIDE THE INSTALLED FIXTURE UNIT.

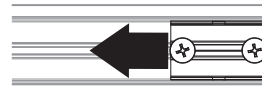

- 3- INSERT LAST FIXTURE UNIT FOLLOWING STEPS H T O J.

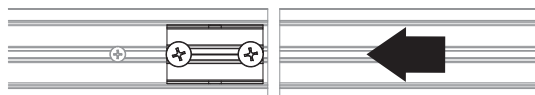

- 4- PUSH MECHANICAL JOINER BACK INTO PLACE LEAVING 1" ON EACH SIDE THEN TIGHTEN BOTH SCREWS. DO NOT OVERTIGHTEN THE SCREWS.

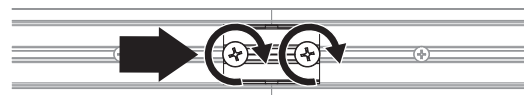

1" (25.4mm) | | 1" (25.4mm)

RECESSED CUT-OUT DIMENSIONS

IN LINE SYSTEM

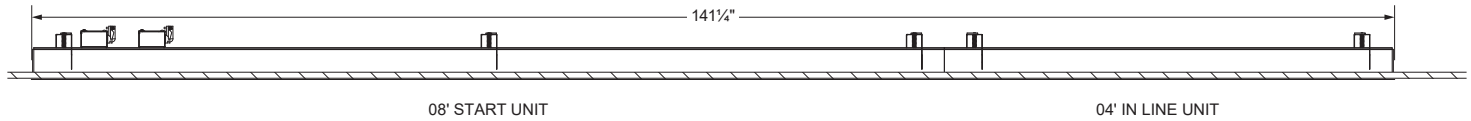

| CUT-OUT FOR LINEAR RECESSED ALL CONFIGURATIONS | | |
|---|-----------------------|-------------------------------------|
| Nominal length | Actual length (A) | Cut-out |
| 04' | 3'-11" (1.194m) | 1 3/4" x 46 3/4" (44mm x 1.189m) |
| 08' | 7'-11" (2.413m) | 1 3/4" x 94 3/4" (44mm x 2.409m) |
| 12' | 11'-9 3/8" (3.591m) | 1 3/4" x 141 1/4" (44mm x 3.589m) |
| 16' | 15'-9 3/8" (4.810m) | 1 3/4" x 189 1/4" (44mm x 4.808m) |
| 20' | 19'-7 7/8" (5.991m) | 1 3/4" x 235 3/4" (44mm x 5.988m) |
| 24' | 23'-7 7/8" (7.210m) | 1 3/4" x 283 3/4" (44mm x 7.207m) |
| 28' | 27'-6 3/8" (8.391m) | 1 3/4" x 330 3/8" (44mm x 8.387m) |
| 32' | 31'-6 3/8" (9.611m) | 1 3/4" x 378 3/8" (44mm x 9.606m) |
| 36' | 35'-4 3/4" (10.789m) | 1 3/4" x 424 5/8" (44mm x 10.786m) |
| 40' | 39'-4 3/4" (12.008m) | 1 3/4" x 472 5/8" (44mm x 12.005m) |
| 44' | 43'-3 1/4" (13.189m) | 1 3/4" x 519" (44mm x 13.185m) |
| 48' | 47'-3 1/4" (14.408m) | 1 3/4" x 567" (44mm x 14.404m) |
| 52' | 51'-1 5/8" (15.586m) | 1 3/4" x 613 1/2" (44mm x 15.584m) |
| 56' | 55'-1 5/8" (16.805m) | 1 3/4" x 661 1/2" (44mm x 16.803m) |
| 60' | 59'-1 5/8" (17.986m) | 1 3/4" x 708" (44mm x 17.983m) |
| 64' | 63'-1 5/8" (19.206m) | 1 3/4" x 756" (44mm x 19.202m) |
| 68' | 66'-10 1/2" (20.384m) | 1 3/4" x 802 3/8" (44mm x 20.382m) |
| 72' | 70'-10 1/2" (21.603m) | 1 3/4" x 850 3/8" (44mm x 21.601m) |
| 76' | 74'-9" (22.784m) | 1 3/4" x 896 3/4" (44mm x 22.781m) |
| 80' | 78'-9" (24.003m) | 1 3/4" x 944 3/4" (44mm x 24m) |
| 84' | 82'-7 1/2" (25.184m) | 1 3/4" x 991 1/4" (44mm x 25.180m) |
| 88' | 86'-7 1/2" (26.403m) | 1 3/4" x 1039 1/4" (44mm x 26.400m) |
| 92' | 90'-5 7/8" (27.581m) | 1 3/4" x 1085 3/4" (44mm x 27.579m) |
| 96' | 94'-5 7/8" (28.800m) | 1 3/4" x 1133 3/4" (44mm x 28.798m) |
| 100' | 98'-4 3/8" (29.981m) | 1 3/4" x 1180 1/4" (44mm x 29.978m) |