

Slim high or compact profile pendant luminaire with uplight general lighting and iGuzzini 48V low voltage track. Compatible with iGuzzini 48V low voltage products.

**Luminaire characteristics:
(uplight)**

Power input: 5.1W/ft, 7.6W/ft or 10.3W/ft
Lumens: 418lm/ft to 1004lm/ft (3000K, 90CRI)
Luminaire efficacy: Up to 102lm/W

source: High efficiency Osram LED (LM-80)
3000K: 90CRI,
3500K: 90CRI,
4000K: 90CRI.

Lumen maintenance: 90% of initial lumens at 90 000 hours (L90) (LM-79).

Optics: General light frosted and microprismatic uplight with track.

Material: Body: Extruded aluminum profile with die-cast end caps.
Diffuser: PMMA
Mounting: Stainless steel suspension cable, power cable and die-cast canopy.

Mounting: Supplied with a 5' (1.5m) long ultra thin suspension aircraft cable (field adjustable) and canopy. To be installed on a standard 4" octagonal junction box.

Electrical: Integral high efficiency electronic LED driver, rated 50 000 hours, 120-277V. Low voltage track option to be used only with iGuzzini 48V low voltage modules.

Dimming: 0-10V (120-277V) or DALI (120-277V) down to 5%.

Finish: Available in white RAL9010 or black RAL9004.
The canopy is supplied white, other finishes available on request.

Weight: 1.62 lbs/ft (0.73 kg/ft)

Warranty: 5 year limited warranty.

Ratings: IP20

Certification:  cULus listed for dry location.

MADE IN CANADA.

FAMILY OVERVIEW

Linear small family offers a wide range of mounting and optic options for multiple applications

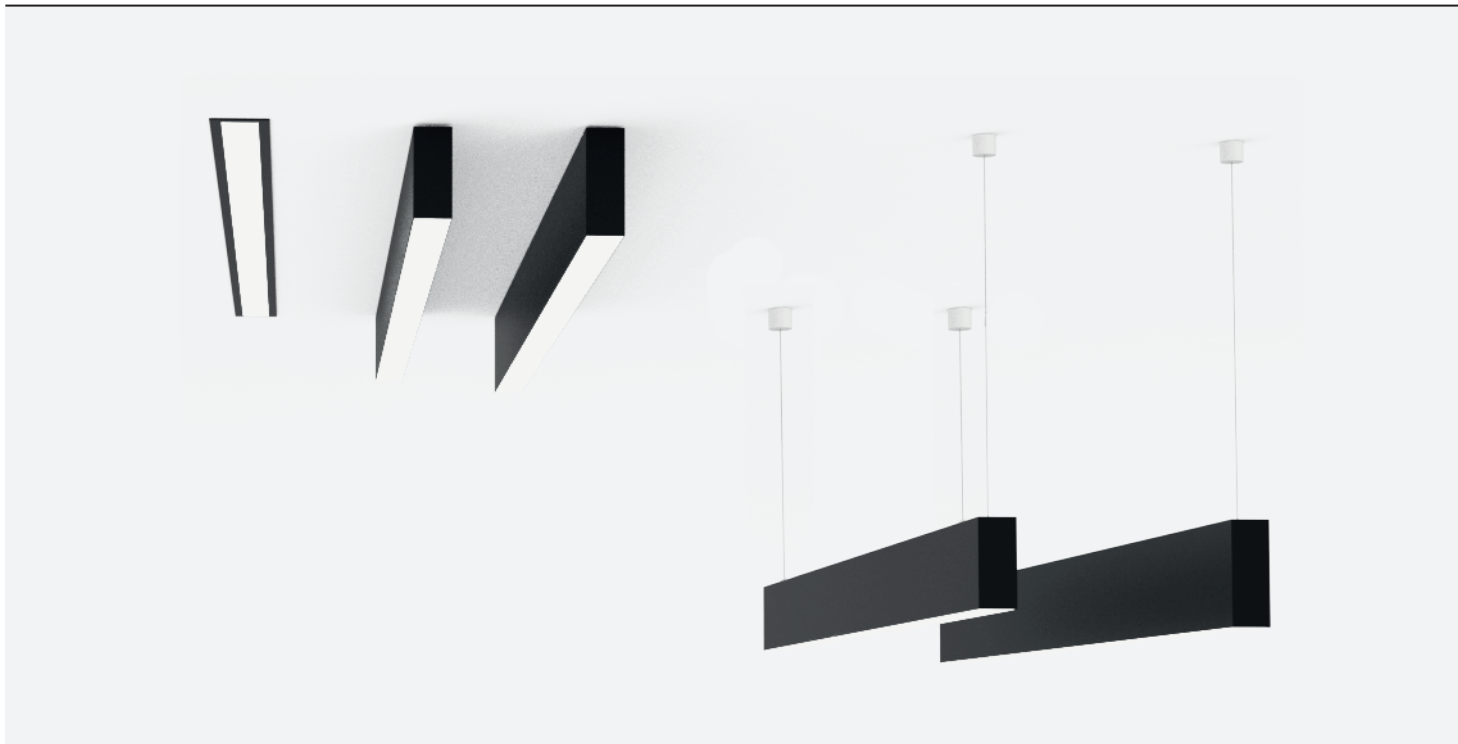

GENERAL LIGHT
MICROPRISMATIC

GENERAL LIGHT
FROSTED

LOW VOLTAGE
48V TRACK

LASER BLADE XS
coming soon

Powered by **iGuzzini**

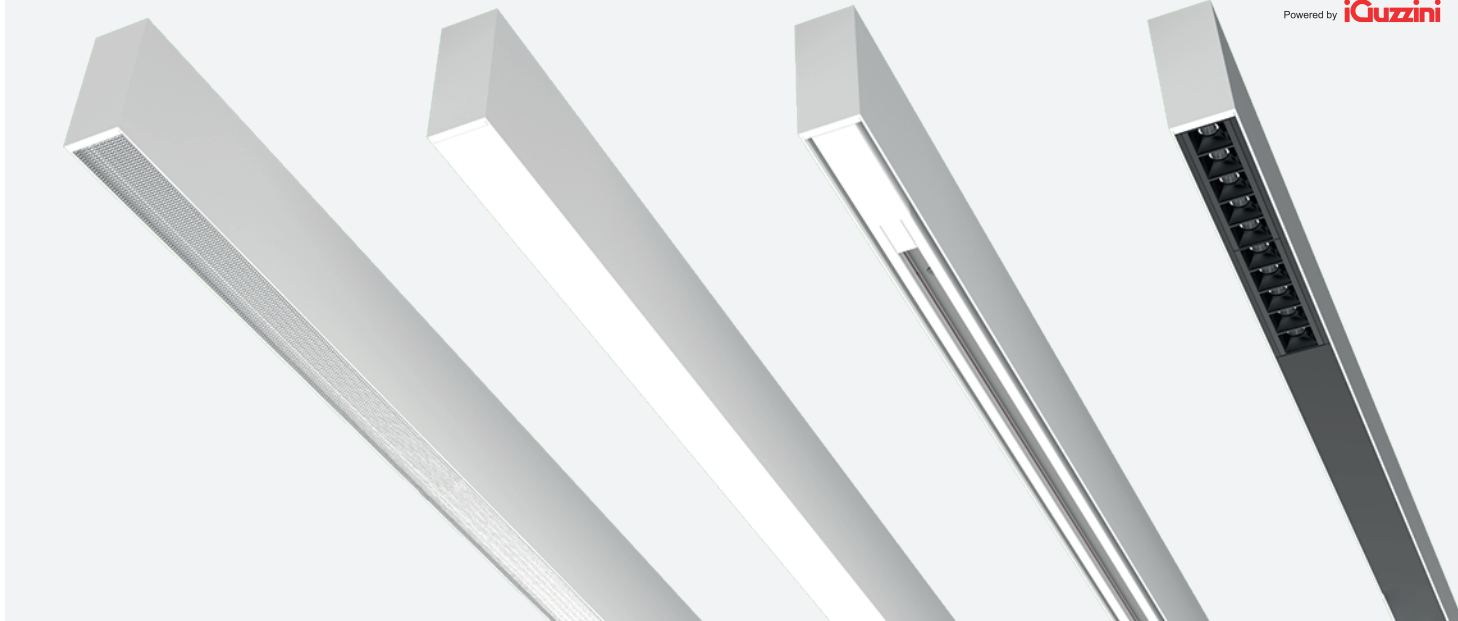

PRODUCT FEATURES

PROPRIETARY LED PLATFORM

Superior thermal management for reliable color consistency and optimized output performance.

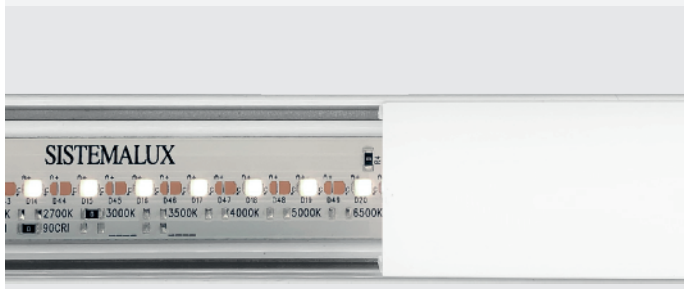

PROFESSIONAL GRADE OPTICS

PMMA premium quality optics designed for visual comfort and performance.



SOPHISTICATED SLIM PROFILE

Minimalist slim shape for subtle integration with architecture.

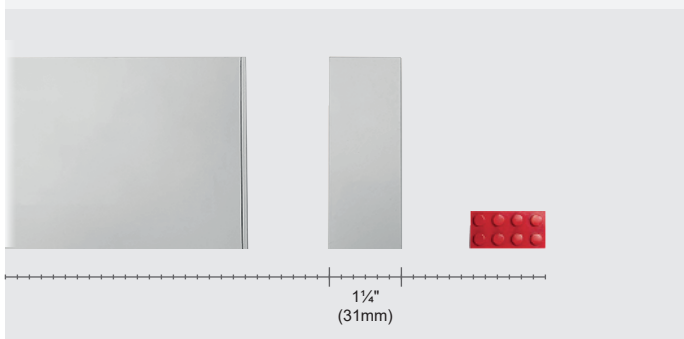

HIDDEN SUSPENSION ADJUSTMENT MECHANISM

Cable adjustment and lock mechanism designed to be invisible to keep a clean look.

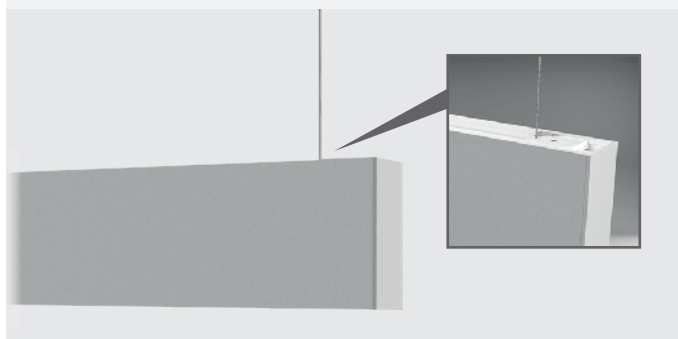

SIZE COMPARISON

Smaller form factor with no compromise on the performance.

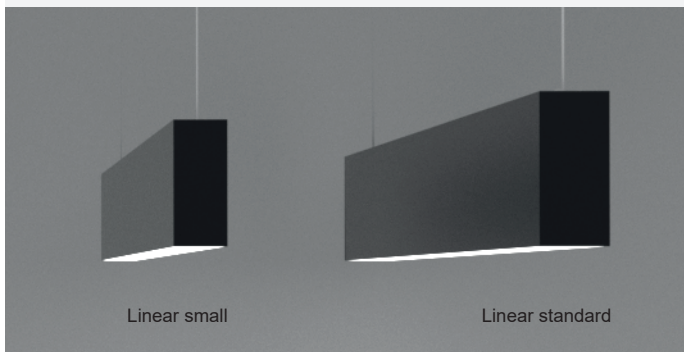

PRODUCT COMPATIBILITY

iGUZZINI PALCO LOW VOLTAGE SPOTLIGHT*

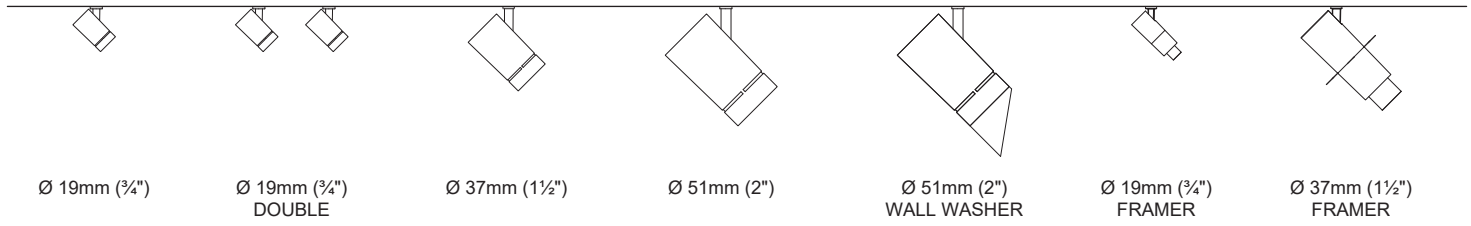

iGUZZINI LASER BLADE XS LOW VOLTAGE TRACK MODULES*

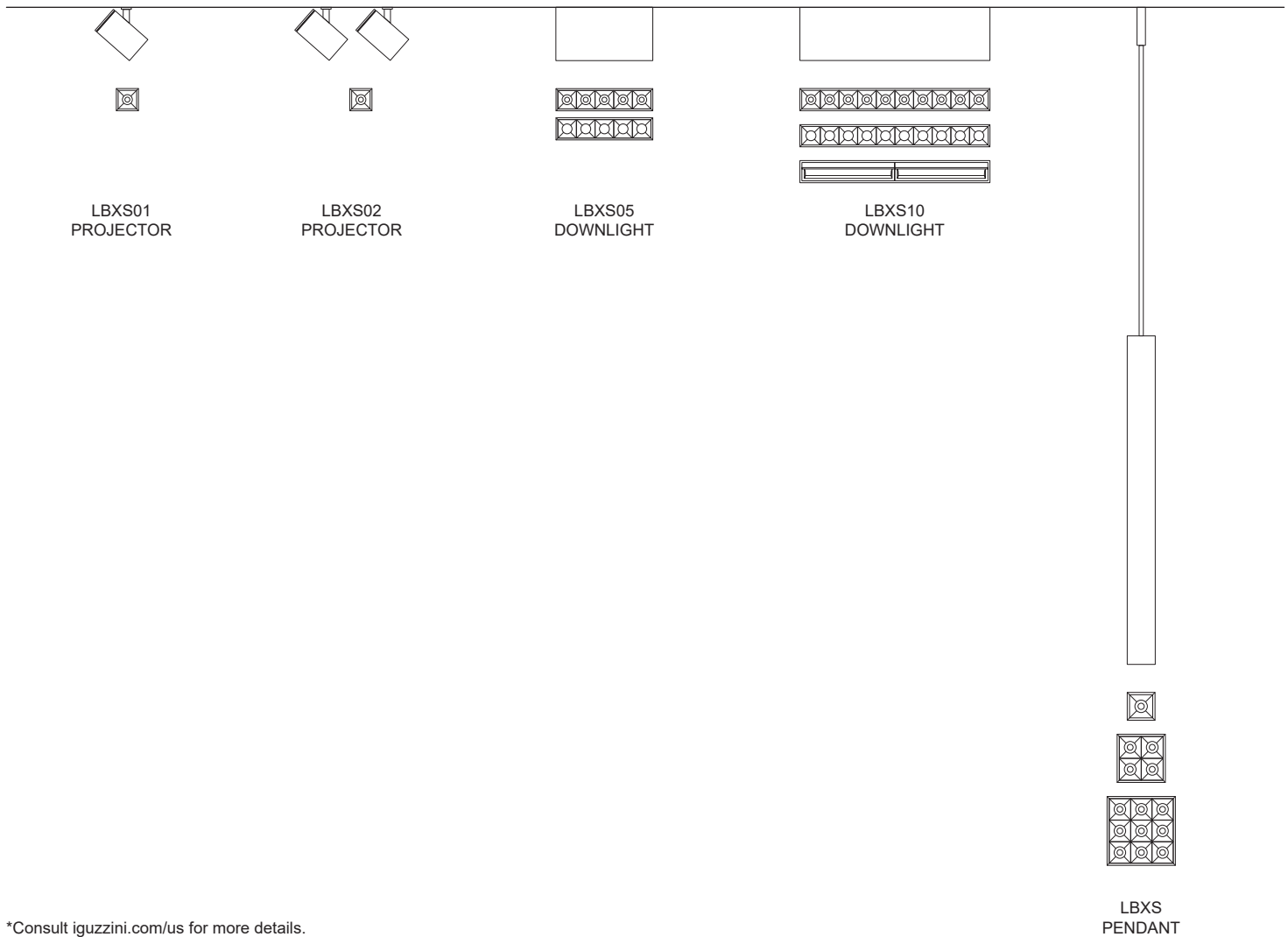

*Consult iguzzini.com/us for more details.

DIMENSIONS

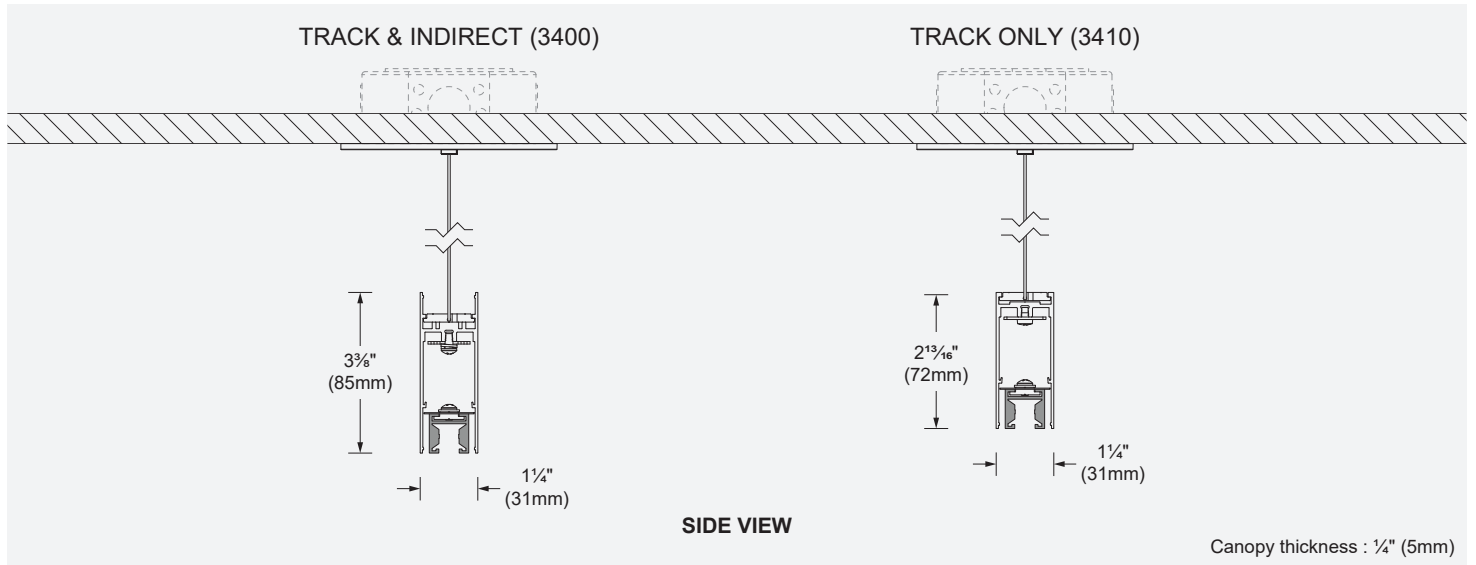

LENGTHS

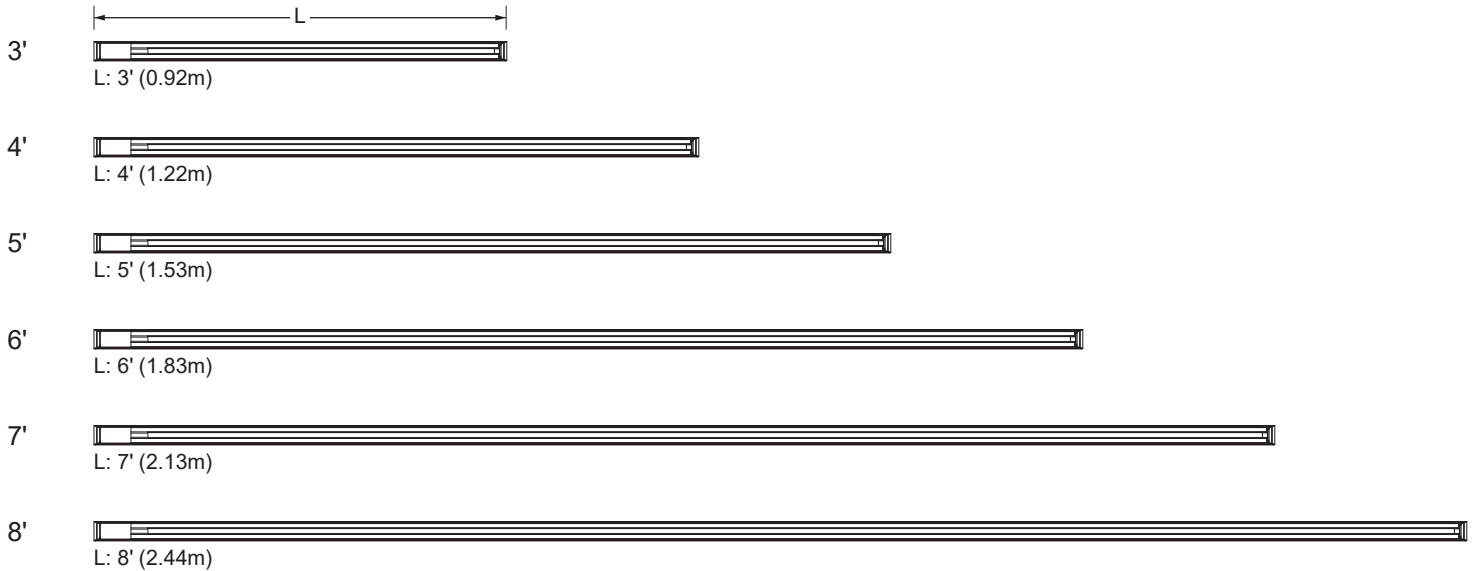

Longer lengths available. See ordering info p.5.

LED COLOR FIDELITY DATA

CCT	R1	R2	R3	R4	R5	R6	R7	R8	R9	R10	R11	R12	R13	R14	R15	Rf	Rg	Melanopic ratio
3000K	91	94	96	91	91	93	92	80	54	86	91	83	92	97	87	91	100	0.535
3500K	95	96	95	94	94	94	94	87	67	88	95	80	95	96	92	92	101	0.641
4000K	92	100	94	94	91	94	93	91	77	84	93	71	94	95	93	92	100	0.716

PHOTOMETRIC DATA

Visit sistemalux.com for complete photometric data.

INDIRECT OUTPUT

CCT (K)	CRI	OUTPUT	LOAD (W / ft)	OPTIC	LUMENS (lm / ft)	EFFICACY (lm / W)	MODELS
3000K	90	BO	5.1W/ft	Frosted	418	81	3400-BO-930-F
				Microprismatic	524	102	3400-BO-930-M
		MO	7.6W/ft	Frosted	619	81	3400-MO-930-F
				Microprismatic	770	101	3400-MO-930-M
		HO	10.3W/ft	Frosted	752	73	3400-HO-930-F
				Microprismatic	1 004	97	3400-HO-930-M

*USE MULTIPLIER TABLE FOR OTHER CCT AND CRI OUTPUT DATA

BO Frosted (3000K, 90CRI)

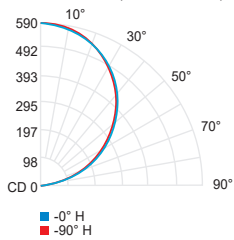

MO Frosted (3000K, 90CRI)

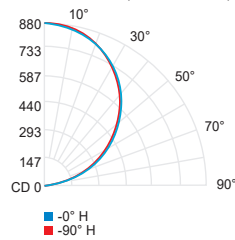

HO Frosted (3000K, 90CRI)

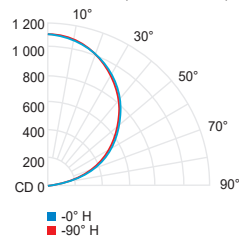

BO Microprismatic (3000K, 90CRI)

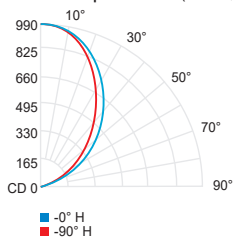

MO Microprismatic (3000K, 90CRI)

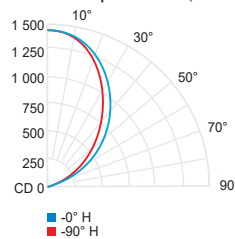

HO Microprismatic (3000K, 90CRI)

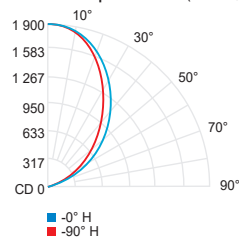

CCT options	3000K	3500K	4000K
CRI options	90CRI	90CRI	90CRI
Multiplier	1	1.03	1.06

INSTALLATION OPTIONS (INCLUDED)

DEFAULT OPTION

The aircraft cable suspension and power cable terminate at the canopy.



ALTERNATE OPTION

The aircraft cable suspension terminates in the ceiling while the power cable and the canopy cover can be located independently.

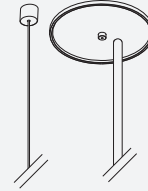

MOUNTING ACCESSORIES (TO BE ORDERED SEPARATELY)

*for installation consult the instruction sheet

- 3637** - Accessory for T-Bar Mounting (White) 1 Kit includes 2 anchors
*for installation consult the instruction sheet



Length	# of kits needed
Up to 8'	1
8' to 24'	2
25' to 40'	3
41' to 56'	4
57' to 72'	5
73' to 88'	6
89' to 96'	7

ORDERING INFO

- - **LZ** **T UNV**
FIXTURE



MODEL

- 3400** - Pendant low voltage track & indirect **3410** - Pendant low voltage track

LENGTH

_____ 3' to 96'

INDIRECT OUTPUT⁽¹⁾

- NO** - None **BO** - Base output **MO** - Medium output **HO** - High output

TRACK

- LZ** - Low voltage 48V

LED⁽¹⁾

- NA** - No LED⁽²⁾ **930** - 3000K, 90CRI **935** - 3500K, 90CRI **940** - 4000K, 90CRI

INDIRECT OPTIC⁽¹⁾

- N** - None (cover plate)⁽³⁾ **F** - Frosted **M** - Microprismatic

- T** - Track

VOLTAGE

- UNV** - 120-277V

FINISH

- 01** - White **02** - Black

DIMMING

- D10** - 0-10V (down to 5%) **DA** - Dali (down to 5%)

⁽¹⁾ Available for pendant low voltage track & indirect (**3400**) model.

⁽²⁾ A cover plate will be installed when no (**NO**) indirect output is selected.

⁽³⁾ Available for no (**NO**) indirect output.