



Proprietary industry leading linear LED platform with superior thermal management that yields reliable color consistency and output performance. The dedicated heat sink maintains the LED temperature at minimal level to ensure reliability in all conditions. Available as single module or continuous runs. Suitable for interior applications where general lighting is desired.

General light characteristic:

Power input: 5, 7.5, 10.5 or 20W/ft
Lumens: 350, 550, 700 or 1400lm/ft (for 3000K, 85CRI)
Luminaire efficacy: Up to 75lm/W

Accent light characteristic:

Power input: 13.5W (per lamp)
Lumens: 1200lm per lamp (for 3000K, 80CRI)
Luminaire efficacy: Up to 92lm/W

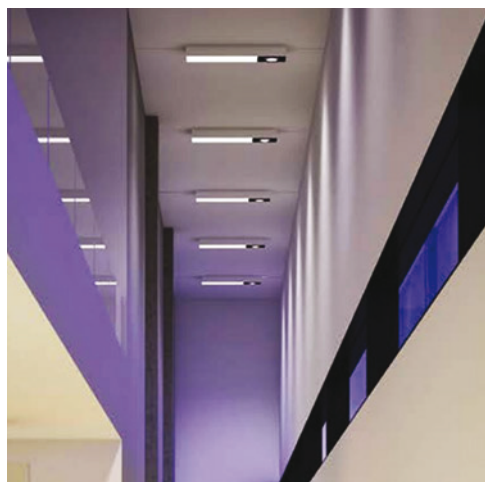

General light source:

Osram Duris®E5 JDSR (LM-80 tested)
3000K : 85CRI typical (min>80CRI)
3500K : 85CRI typical (min>80CRI)
4000K : 85CRI typical (min>80CRI)

Lumen maintenance:

70% of initial lumens at 100 000 hours (L70) (LM-79 tested).

Accent light source:

BRIDGELUX VERO13 LED module (LM-80 tested)
3000K : 80CRI
3500K : 80CRI
4000K : 80CRI

Lumen maintenance:

90% of initial lumens at 100 000 hours (L90) (LM-79 tested).

General light optic:

General lighting

Accent light optic:

Spot, Narrow Flood, Flood, or Wide Flood. Each optical assembly is adjustable 30° in all axes.

Material:

Body: Extruded aluminum
End caps: Die-cast aluminum
Optical assembly: Die-cast aluminum
General lighting reflector: Whitelite 92% of reflectivity
Accent lighting reflector: High bright anodized aluminum
General lighting diffuser: Frosted PMMA acrylic

Mounting:

Surface mounted with included brackets. Installs on a standard 4" junction box.

Electrical:

Integral high efficiency electronic power supply, rated 50 000 hours, 120-277V. Supplied standard with 2 circuits (circuit 1: general lighting, circuit 2: accent light).

Dimming:

0-10V (down to 15%) supplied standard with 1 circuit only. 2 circuits available upon request, with additional canopy.

Finish:

White (RAL9003), gray (RAL9006), black (RAL9004), white with black front plate or gray with black front plate painted finish.

Warranty:

5 year limited warranty.

Ratings:

IP20

Certification:



cULus listed for damp location. Interior use only.



ORDERING INFO

8604 - - - - **F - UNV** - -
FIXTURE

MODEL

8604 - Surface

CONFIGURATION

CA **CC** **CE**
 CB **CD** **CF**

ACCENT LIGHT OPTIC

20 - 24° Spot **30** - 30° Narrow Flood **40** - 39° Flood **60** - 58° Wide Flood

GENERAL LIGHT OUTPUT*

B - Base output **M** - Medium output **H** - High output **VH** - Very high output **NA**

LED

830 - 3000K **835** - 3500K **840** - 4000K

GENERAL LIGHT OPTIC

F - Frosted

VOLTAGE

UNV - 120-277V

FINISH

01 - White **02** - Black **10** - Gray **21** - White with black front plate **22** - Gray with black front plate

DIMMING

D10** - 0-10V (down to 15%)

* No General Light applicable for CC configuration (accent light only).

** 0-10V dimming supplied standard with 1 circuit only. 2 circuits available upon request, with additional canopy.

CONFIGURATION

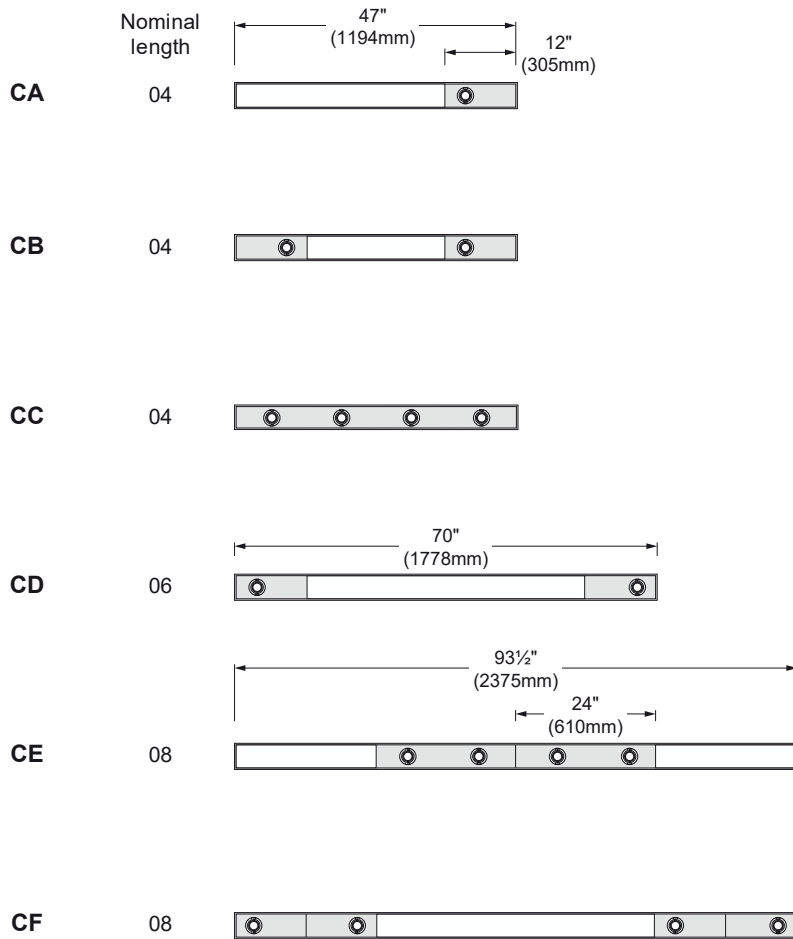

DIMENSION

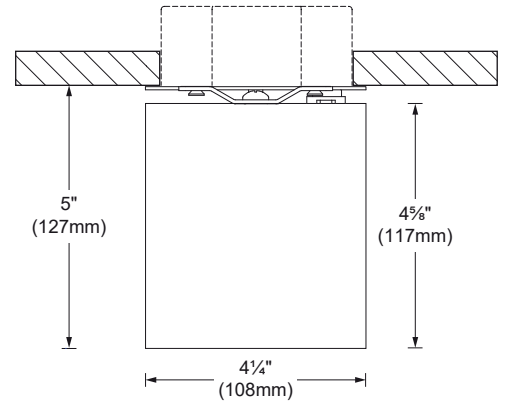

SIDE VIEW

MOUNTING

Canopy comes in white, for other colors contact factory.

LED COLOR FIDELITY DATA

CCT	R1	R2	R3	R4	R5	R6	R7	R8	R9	R10	R11	R12	R13	R14	R15	Rf	Rg	Melanopic ratio
3000K	80	88	95	82	80	84	85	62	10	72	82	67	82	97	73	83	99	0.478
3500K	82	89	95	84	83	86	86	65	13	75	85	71	84	97	75	85	99	0.578
4000K	84	90	94	85	85	87	87	69	21	77	85	70	86	97	79	86	98	0.689

PHOTOMETRIC DATA

Photometric performance is measured at an accredited independant laboratory in accordance with IESNA LM-79. Visit sistemalux.com for complete photometric data.

GENERAL LIGHT

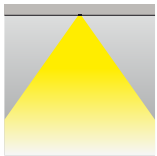

CCT (K)	CRI	OUTPUT	LOAD (W/ft)	LUMENS (lm/ft)	EFFICACY (lm/W)	MODELS
3000K	85	B	5W/ft	395	75	8604-XXXXB830
		M	7.5W/ft	585	75	8604-XXXXM830
		H	10.5W/ft	745	70	8604-XXXXH830
		VH	20W/ft	1460	70	8604-XXXXVH830

*USE MULTIPLIER TABLE FOR OTHER CCT AND CRI OUTPUT DATA

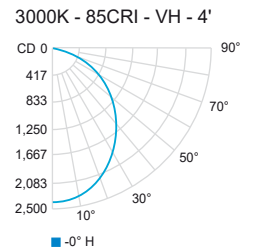
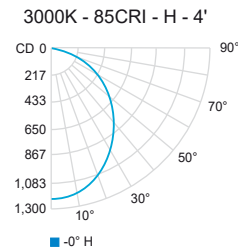
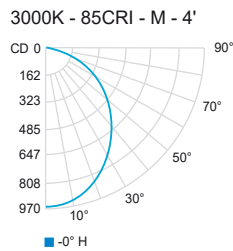
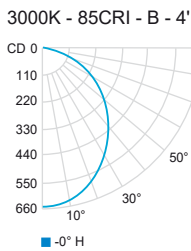

CCT options	3000K	3500K	4000K
CRI options	85CRI	85CRI	85CRI
Multiplier	1	1.09	1.19

LED COLOR FIDELITY DATA

CRI	CCT	R1	R2	R3	R4	R5	R6	R7	R8	R9	R10	R11	R12	R13	R14	R15	Rf	Rg	Melanopic ratio
80	3000K	82	92	97	83	83	90	84	61	12	81	82	75	85	99	75	86	96	0.52
	3500K	81	89	95	80	80	84	85	63	9	73	78	61	82	97	75	83	97	0.58
	4000K	80	88	93	81	80	83	87	66	10	71	79	56	82	96	74	83	95	0.67

PHOTOMETRIC DATA

Photometric performance is measured at an accredited independent laboratory in accordance with IESNA LM-79. Visit sistemalux.com for complete photometric data.

ACCENT LIGHT

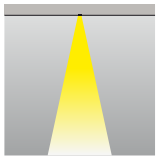

REFER TO ONE LAMP

CCT (K)	CRI	OPTIC	LOAD (W)	LUMENS (lm)	EFFICACY (lm/W)	MAX CANDELA (cd)	MODELS
3000K	80	Spot	13.5W	1250	92	4015	8604-CA20X830
		Narrow Flood		1195	88	2915	8604-CA30X830
		Flood		1205	89	2205	8604-CA40X830
		Wide Flood		1230	91	1470	8604-CA60X830

*USE MULTIPLIER TABLE FOR OTHER CCT AND CRI OUTPUT DATA

Spot 24° (3000K, 80 CRI)

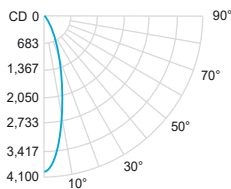

Center Beam fc	Beam Width ft	
2ft	1,004	0.9
4ft	251	1.7
6ft	112	2.6
8ft	62.8	3.2
10ft	40.2	4.4
12ft	27.9	5.2

Narrow Flood 30° (3000K, 80 CRI)

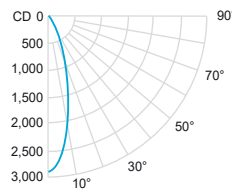

Center Beam fc	Beam Width ft	
2ft	729	1.1
4ft	182	2.2
6ft	81.0	3.3
8ft	45.5	4.4
10ft	29.2	5.5
12ft	20.2	6.6

Flood 39° (3000K, 80 CRI)

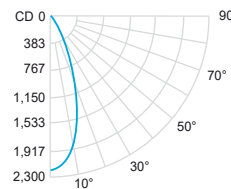

Center Beam fc	Beam Width ft	
2ft	552	1.4
4ft	138	2.9
6ft	61.3	4.3
8ft	34.5	5.7
10ft	22.1	7.1
12ft	15.3	8.6

Wide Flood 58° (3000K, 80 CRI)

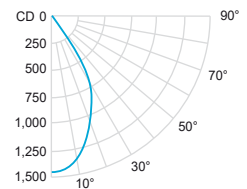

Center Beam fc	Beam Width ft	
2ft	368	2.2
4ft	91.9	4.5
6ft	40.8	6.7
8ft	23.0	9.0
10ft	14.7	11.2
12ft	10.2	13.4

CCT options	3000K	3500K	4000K
CRI options	80CRI	80CRI	80CRI
Multiplier	1	1.03	1.04